

SIRIUS HRI



Areas of application

- Concert Lighting
- Club & Disco
- Stage & Theatre
- Studio, TV, & Film
- Architecture & Architainment

Product features and benefits

- Lightweight and compact reflector lamps with optimized ECG
- High luminance through very short arc and high pressure
- Optimized burner design allows any burning position
- Stable light output over the entire lifetime
- Stable light output over the entire lifetime
- Easy lamp replacement
- Easy lamp replacement



Product family datasheet

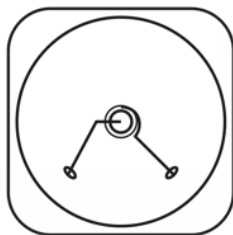
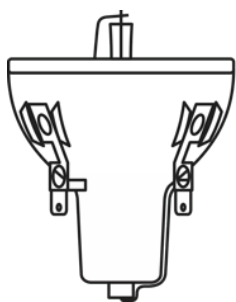

SIRIUS HRI 100W

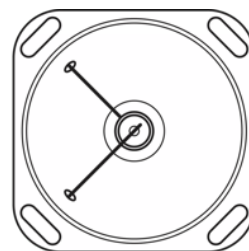
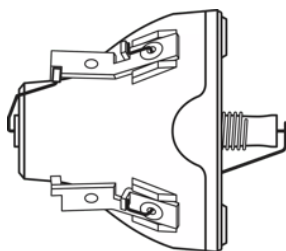

SIRIUS HRI 132W

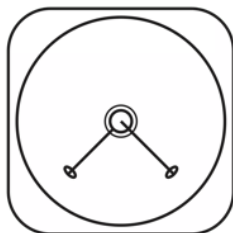
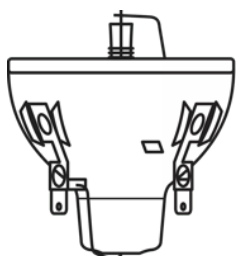

SIRIUS HRI 132W

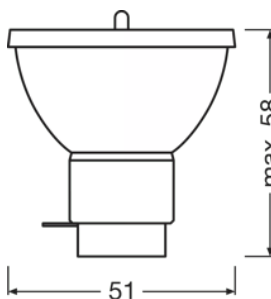

SIRIUS HRI 251W

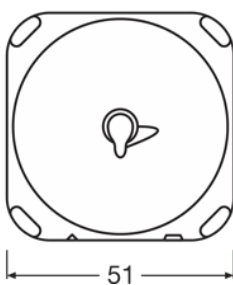
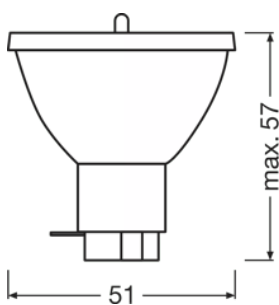

SIRIUS HRI 295 W

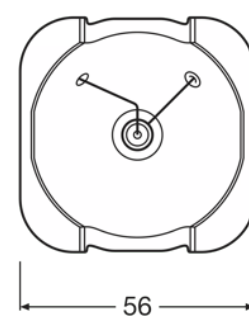
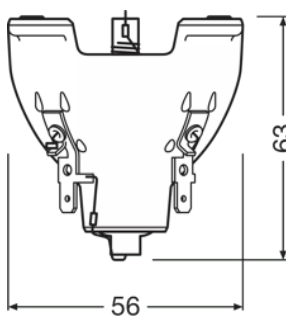

SIRIUS HRI 330W

Product family datasheet

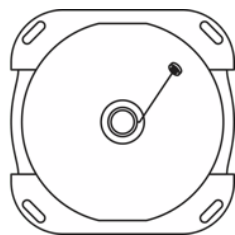
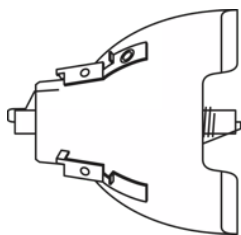

SIRIUS HRI 330W

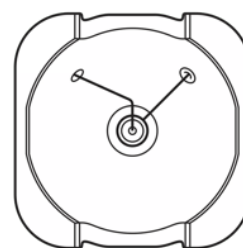
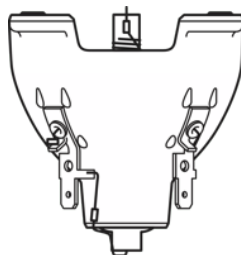

SIRIUS HRI 330W

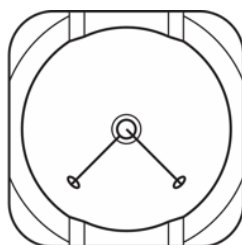
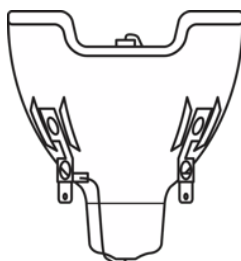

SIRIUS HRI 330W X8

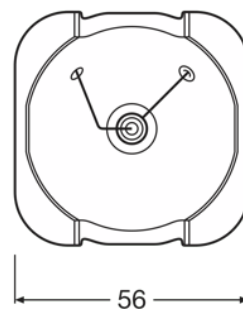
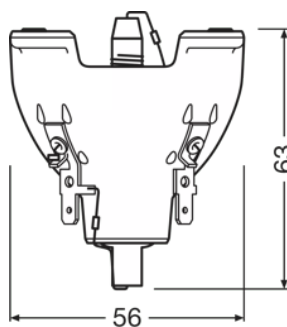

Sirius HRI 330W XL

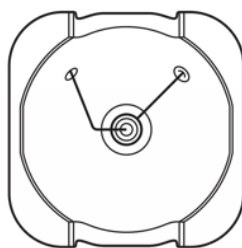
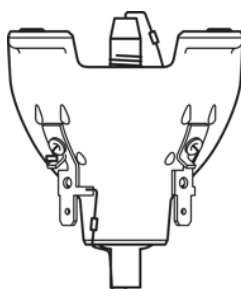

Sirius HRI 330W XL

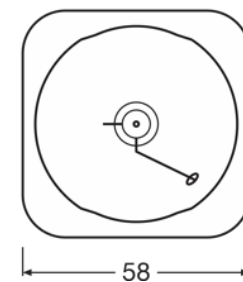
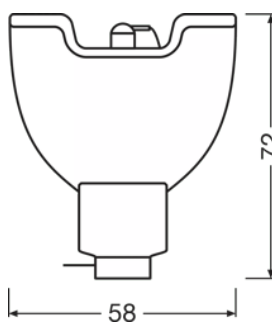

SIRIUS HRI 371W

Product family datasheet

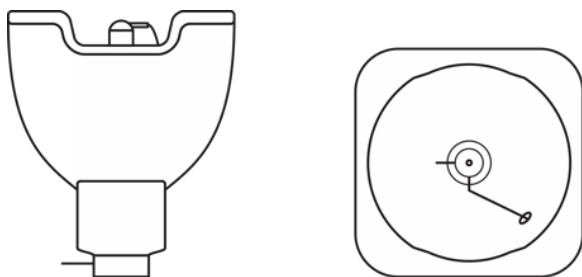

SIRIUS HRI 371W

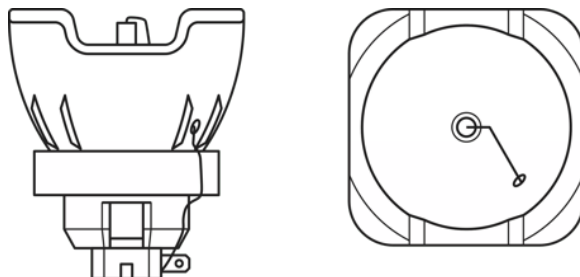

SIRIUS HRI 440W

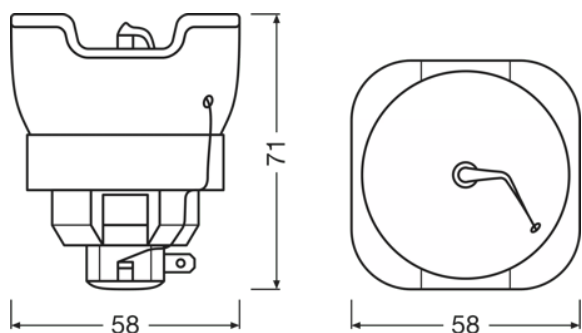

SIRIUS HRI 580 F

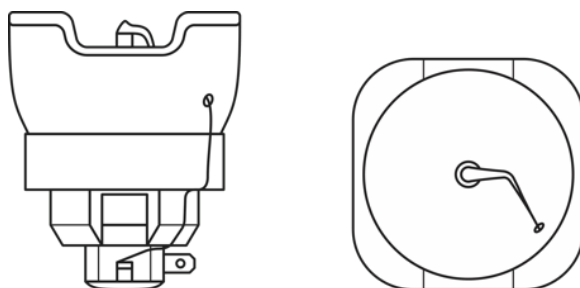

SIRIUS HRI 580 F

Product family datasheet

Technical data

Product description	General Product Information	Electrical Data	Photometric Data	
	Category	Nominal wattage	Nominal luminous flux	Working distance
SIRIUS HRI 100 W	CORE	100 W	3680 lm	30 mm
SIRIUS HRI 132 W SC	CORE	132 W	5150 lm	37.7 mm
SIRIUS HRI 140 W RO	CUSTOMIZED	140 W	5400 lm	37.7 mm
SIRIUS HRI 190 W+	CORE	190 W	8100 lm	34.5 mm
SIRIUS HRI 230 W	CORE	230 W	9500 lm	34.5 mm
SIRIUS HRI 231 W	VALUE	231 W	10800 lm	34.5 mm
SIRIUS HRI 251 W	VALUE	251 W	12000 lm	38 mm
SIRIUS HRI 260 W PRO	PRO	260 W	13500 lm	34.5 mm
SIRIUS HRI 280 W	CORE	280 W	11500 lm	34.5 mm
SIRIUS HRI 280 W RO	CUSTOMIZED	280 W	11500 lm	34.5 mm
SIRIUS HRI 281 W	VALUE	281 W	13000 lm	34.5 mm
SIRIUS HRI 295 W	CORE	295 W	11300 lm	34.5 mm
SIRIUS HRI 310 W	CORE	310 W	15000 lm	36.5 mm
SIRIUS HRI 310 W RO	CUSTOMIZED	310 W	13500 lm	48 mm
SIRIUS HRI 310 W PRO	PRO	310 W	15500 lm	37.4 mm
SIRIUS HRI 310 W S PRO	PRO	310 W	15500 lm	31.4 mm
SIRIUS HRI 311 W	VALUE	311 W	14500 lm	31.4 mm
SIRIUS HRI 330 W	CORE	330 W	18000 lm	31 mm
SIRIUS HRI 330 W X8	CUSTOMIZED	330 W	18000 lm	37.4 mm
SIRIUS HRI 330 W XL	CORE	330 W	16500 lm	36 mm
SIRIUS HRI 371 W +	CORE	371 W	18300 lm	37.4 mm
SIRIUS HRI 371 W S +	CORE	371 W	19800 lm	31.4 mm
SIRIUS HRI 371 W	VALUE	371 W	18300 lm	31.4 mm
SIRIUS HRI 371 W S	VALUE	371 W	19800 lm	37.4 mm
SIRIUS HRI 381 W S	CUSTOMIZED	381 W	20000 lm	34.4 mm
SIRIUS HRI 380 W Pro	PRO	380 W	20000 lm	31.4 mm
SIRIUS HRI 380 W S PRO	PRO	380 W	20000 lm	31.4 mm
SIRIUS HRI 382 W S	CORE	382 W	20000 lm	31.4 mm
SIRIUS HRI 382 W	CORE	382 W	21000 lm	37.4 mm
SIRIUS HRI 420 W	CORE	420 W	22000 lm	34.4 mm
SIRIUS HRI 420 W S	CORE	420 W	21000 lm	34.4 mm
SIRIUS HRI 440 W	CORE	440 W	22000 lm	41 mm
SIRIUS HRI 440 W H	CUSTOMIZED	440 W	18000 lm	60 mm
SIRIUS HRI 440 W +	CORE	440 W	22800 lm	41 mm
SIRIUS HRI 440 W S	CORE	440 W	22800 lm	37.4 mm
SIRIUS HRI 440 W X	CUSTOMIZED	440 W	22800 lm	41 mm
SIRIUS HRI 461 W	VALUE	461 W	24000 lm	41 mm
SIRIUS HRI 461 W S	VALUE	461 W	24000 lm	37.4 mm
SIRIUS HRI 462 W	CORE	462 W	24000 lm	41 mm
SIRIUS HRI 470 W	CORE	470 W	20500 lm	41 mm
SIRIUS HRI 470 W S	CORE	470 W	21500 lm	37.4 mm

Product family datasheet

Product description	General Product Information	Electrical Data	Photometric Data	
	Category	Nominal wattage	Nominal luminous flux	Working distance
SIRIUS HRI 470 W RO	CUSTOMIZED	470 W	19500 lm	48 mm
SIRIUS HRI 470 W XL	CORE	470 W	24000 lm	59 mm
SIRIUS HRI 471 W SN	VALUE	471 W	20000 lm	41 mm
SIRIUS HRI 550 W XL	CORE	550 W	28000 lm	59 mm
SIRIUS HRI 550 W	CORE	550 W	28000 lm	41 mm
HRI 580 W F	CUSTOMIZED	580 W	29500 lm	60 mm

Product description	Physical Attributes & Dimensions			
	Electrode gap (cold)	Lamp base	Diameter	Diameter
SIRIUS HRI 100 W	1.0 mm	SPEZIAL	45.0 mm	45.0 mm
SIRIUS HRI 132 W SC	1.0 mm	-	46.0 mm	46.0 mm
SIRIUS HRI 140 W RO	1.0 mm	-	46.0 mm	46.0 mm
SIRIUS HRI 190 W+	-	-	51.0 mm	51.0 mm
SIRIUS HRI 230 W	1.0 mm	-	51.0 mm	51.0 mm
SIRIUS HRI 231 W	1.0 mm	-	51.0 mm	51.0 mm
SIRIUS HRI 251 W	-	-	51.0 mm	51.0 mm
SIRIUS HRI 260 W PRO	0.9 mm	-	51.0 mm	51.0 mm
SIRIUS HRI 280 W	0.9 mm	-	51.0 mm	51.0 mm
SIRIUS HRI 280 W RO	0.9 mm	-	51.0 mm	51.0 mm
SIRIUS HRI 281 W	1.0 mm	-	51.0 mm	51.0 mm
SIRIUS HRI 295 W	-	-	51.0 mm	51.0 mm
SIRIUS HRI 310 W	-	-	51.0 mm	51.0 mm
SIRIUS HRI 310 W RO	-	-	60.0 mm	60.0 mm
SIRIUS HRI 310 W PRO	0.9 mm	-	58.0 mm	58.0 mm
SIRIUS HRI 310 W S PRO	0.9 mm	-	58.0 mm	58.0 mm
SIRIUS HRI 311 W	-	-	51.0 mm	51.0 mm
SIRIUS HRI 330 W	1.0 mm	-	56.0 mm	56.0 mm
SIRIUS HRI 330 W X8	1.0 mm	-	58.0 mm	58.0 mm
SIRIUS HRI 330 W XL	1.0 mm	-	56.0 mm	56.0 mm
SIRIUS HRI 371 W +	1.2 mm	-	58.0 mm	58.0 mm
SIRIUS HRI 371 W S +	1.2 mm	-	58.0 mm	58.0 mm
SIRIUS HRI 371 W	1.0 mm	-	58.0 mm	58.0 mm
SIRIUS HRI 371 W S	1.2 mm	-	58.0 mm	58.0 mm
SIRIUS HRI 381 W S	-	-	58.0 mm	58.0 mm
SIRIUS HRI 380 W Pro	-	-	58.0 mm	58.0 mm
SIRIUS HRI 380 W S PRO	-	-	58.0 mm	58.0 mm
SIRIUS HRI 382 W S	1.0 mm	-	58.0 mm	58.0 mm
SIRIUS HRI 382 W	1.0 mm	-	58.0 mm	58.0 mm
SIRIUS HRI 420 W	-	-	58.0 mm	58.0 mm
SIRIUS HRI 420 W S	-	-	58.0 mm	58.0 mm
SIRIUS HRI 440 W	1.3 mm	-	58.0 mm	58.0 mm
SIRIUS HRI 440 W H	1.3 mm	-	65.0 mm	65.0 mm
SIRIUS HRI 440 W +	-	-	58.0 mm	58.0 mm

Product family datasheet

Product description	Physical Attributes & Dimensions			
	Electrode gap (cold)	Lamp base	Diameter	Diameter
SIRIUS HRI 440 W S		-	11.8 mm	11.8 mm
SIRIUS HRI 440 W X	1.0 mm	-	58.0 mm	58.0 mm
SIRIUS HRI 461 W	1.3 mm	-	60.0 mm	60.0 mm
SIRIUS HRI 461 W S	1.3 mm	-	60.0 mm	60.0 mm
SIRIUS HRI 462 W		-	58.0 mm	58.0 mm
SIRIUS HRI 470 W	1.3 mm	-	58.0 mm	58.0 mm
SIRIUS HRI 470 W S	1.3 mm	-	58.0 mm	58.0 mm
SIRIUS HRI 470 W RO	1.2 mm	-	60.0 mm	60.0 mm
SIRIUS HRI 470 W XL	1.3 mm	-	60.0 mm	60.0 mm
SIRIUS HRI 471 W SN	1.3 mm	Side Prong	60.0 mm	60.0 mm
SIRIUS HRI 550 W XL		Side Prong	60.0 mm	60.0 mm
SIRIUS HRI 550 W	1.5 mm	Side Prong	60.0 mm	60.0 mm
HRI 580 W F		-	65.0 mm	65.0 mm

Product description	Length	Product weight	Diameter (in)	Connector: presence
SIRIUS HRI 100 W	53.0 mm	60.00 g		
SIRIUS HRI 132 W SC	max. 44 mm	60.00 g	1.810 in	
SIRIUS HRI 140 W RO	max. 44 mm	60.00 g		
SIRIUS HRI 190 W+	54.5 mm	60.00 g		
SIRIUS HRI 230 W	54.5 mm	60.00 g	2.008 in	
SIRIUS HRI 231 W	50.0 mm	60.00 g		
SIRIUS HRI 251 W	61.0 mm	50.00 g		
SIRIUS HRI 260 W PRO	50.0 mm	60.00 g		
SIRIUS HRI 280 W	54.5 mm	60.00 g	2.008 in	
SIRIUS HRI 280 W RO	54.5 mm	65.00 g		
SIRIUS HRI 281 W	50.0 mm	60.00 g		
SIRIUS HRI 295 W	53.5 mm	63.50 g		
SIRIUS HRI 310 W	53.5 mm	60.00 g		
SIRIUS HRI 310 W RO	67.0 mm	135.00 g		
SIRIUS HRI 310 W PRO	72.0 mm	130.00 g		
SIRIUS HRI 310 W S PRO	72.0 mm	130.00 g		
SIRIUS HRI 311 W	50.0 mm	60.00 g		
SIRIUS HRI 330 W	63.0 mm	75.00 g	2.008 in	
SIRIUS HRI 330 W X8	66.0 mm	100.00 g	0.236 in	
SIRIUS HRI 330 W XL	63.0 mm	75.00 g	0.512 in	
SIRIUS HRI 371 W +	72.0 mm	130.00 g		
SIRIUS HRI 371 W S +	72.0 mm	130.00 g		
SIRIUS HRI 371 W	72.0 mm	130.00 g		
SIRIUS HRI 371 W S	72.0 mm	130.00 g		
SIRIUS HRI 381 W S	72.0 mm	130.00 g		
SIRIUS HRI 380 W Pro	72.0 mm	130.00 g		
SIRIUS HRI 380 W S PRO	72.0 mm	130.00 g		
SIRIUS HRI 382 W S	72.0 mm	136.00 g		Yes
SIRIUS HRI 382 W	72.0 mm	136.00 g		Yes

Product family datasheet

Product description	Length	Product weight	Diameter (in)	Connector: presence
SIRIUS HRI 420 W	72.0 mm	130.00 g		
SIRIUS HRI 420 W S	72.0 mm	130.00 g		
SIRIUS HRI 440 W	71.0 mm	100.00 g		
SIRIUS HRI 440 W H	60.0 mm	160.00 g		
SIRIUS HRI 440 W +	71.0 mm	135.50 g		
SIRIUS HRI 440 W S	71.0 mm	100.00 g		
SIRIUS HRI 440 W X	71.0 mm	135.50 g		
SIRIUS HRI 461 W	67.0 mm	140.00 g		
SIRIUS HRI 461 W S	67.0 mm	140.00 g		
SIRIUS HRI 462 W	72.0 mm	130.00 g		
SIRIUS HRI 470 W	71.0 mm	103.60 g		
SIRIUS HRI 470 W S	71.0 mm	103.60 g		
SIRIUS HRI 470 W RO	67.0 mm	140.00 g		
SIRIUS HRI 470 W XL	67.0 mm	140.00 g		
SIRIUS HRI 471 W SN	67.0 mm	140.00 g		
SIRIUS HRI 550 W XL	67.0 mm	140.00 g		
SIRIUS HRI 550 W	67.0 mm	140.00 g		
HRI 580 W F	65.0 mm	160.00 g		

Product description	Operating Conditions		Lifetime Data	Environmental & Regulatory Information according Art. 33 of EU Regulation (EC) 1907/2006 (RECh)
	Burning position	Cooling	Nominal lifetime	Primary article identifier
SIRIUS HRI 100 W	Any	Forced	6000 hr	4052899329119 4052899321656
SIRIUS HRI 132 W SC	Any	Forced	6000 hr	4052899028708 4052899011335 4052899197404
SIRIUS HRI 140 W RO	Any	Forced	6000 hr	4052899258969 4052899224056
SIRIUS HRI 190 W+			3000 hr	4052899475397 4008321866592
SIRIUS HRI 230 W	Any	Forced	2500 hr	4008321810311
SIRIUS HRI 231 W	Any		2000 hr	4062172128681 4062172212311 4052899553521
SIRIUS HRI 251 W			3000 hr	4062172212458 4062172212434
SIRIUS HRI 260 W PRO			6000 hr	4062172118927 4062172118941
SIRIUS HRI 280 W	Any	Forced	2000 hr	4008321810342
SIRIUS HRI 280 W RO	Any		2000 hr	4052899110397

Product family datasheet

Product description	Operating Conditions		Lifetime Data	Environmental & Regulatory Information according Art. 33 of EU Regulation (EC) 1907/2006 (RECh)
	Burning position	Cooling	Nominal lifetime	Primary article identifier
SIRIUS HRI 281 W	Any		2000 hr	4052899553552 4062172128704
SIRIUS HRI 295 W			2500 hr	4062172283328 4062172283304
SIRIUS HRI 310 W			2500 hr	4062172202169 4062172202183
SIRIUS HRI 310 W RO	Any		3000 hr	4062172140867 4062172140843
SIRIUS HRI 310 W PRO			1500 hr	4062172169424 4062172085304
SIRIUS HRI 310 W S PRO			1500 hr	4062172169455 4062172122825
SIRIUS HRI 311 W			2500 hr	4062172169363
SIRIUS HRI 330 W	Any	Forced	1500 hr	4008321810373
SIRIUS HRI 330 W X8	Any		1500 hr	4052899140325 4052899224346 4052899140295
SIRIUS HRI 330 W XL	Any		1500 hr	4052899195431
SIRIUS HRI 371 W +			3000 hr	4062172110327 4062172110341
SIRIUS HRI 371 W S +			3000 hr	4062172110372 4062172110396
SIRIUS HRI 371 W	Any		1500 hr	4062172057004 4062172056984
SIRIUS HRI 371 W S	Any		1500 hr	4062172056939 4062172056953
SIRIUS HRI 381 W S			2500 hr	4062172226240 4062172226226
SIRIUS HRI 380 W Pro			2500 hr	4062172168601 4062172168625
SIRIUS HRI 380 W S PRO			2500 hr	4062172168311 4062172168335
SIRIUS HRI 382 W S			1500 hr	4062172033541 4062172326100
SIRIUS HRI 382 W			2500 hr	4062172047135 4062172326131
SIRIUS HRI 420 W			2500 hr	4062172192750 4062172192736
SIRIUS HRI 420 W S			2500 hr	4062172192682 4062172392938 4062172393225 4062172192705 4062172392891 4062172393201

Product family datasheet

Product description	Operating Conditions		Lifetime Data	Environmental & Regulatory Information according Art. 33 of EU Regulation (EC) 1907/2006 (RECh)
	Burning position	Cooling	Nominal lifetime	Primary article identifier
SIRIUS HRI 440 W	Any	Forced	1500 hr	4052899259096 4052899222212 4052899587892 4052899570566 4052899553644
SIRIUS HRI 440 W H	Any		1000 hr	4052899576735
SIRIUS HRI 440 W +			1500 hr	4062172348874 4062172047333
SIRIUS HRI 440 W S	Any		1000 hr	4052899329140
SIRIUS HRI 440 W X			1500 hr	4062172017442
SIRIUS HRI 461 W	Any		1500 hr	4052899553613
SIRIUS HRI 461 W S	Any		1500 hr	4052899553583
SIRIUS HRI 462 W			2000 hr	4062172302128 4062172302104
SIRIUS HRI 470 W	Any		1500 hr	4062172169332 4052899580961
SIRIUS HRI 470 W S	Any		1500 hr	4052899580985 4062172169301
SIRIUS HRI 470 W RO	Any		1500 hr	4052899477018
SIRIUS HRI 470 W XL	Any		1500 hr	4062172017473 4062172168281
SIRIUS HRI 471 W SN	Any		1500 hr	4062172040358
SIRIUS HRI 550 W XL			1000 hr	4062172168212 4062172168236
SIRIUS HRI 550 W			1500 hr	4062172008761 4062172078122
HRI 580 W F			1000 hr	4062172085267

Product description	Declaration no. in SCIP database	Candidate list substance 1
SIRIUS HRI 100 W	No declarable substances contained	No declarable substances contained
SIRIUS HRI 132 W SC	No declarable substances contained	No declarable substances contained
SIRIUS HRI 140 W RO	No declarable substances contained	No declarable substances contained
SIRIUS HRI 190 W+	No declarable substances contained	No declarable substances contained
SIRIUS HRI 230 W	No declarable substances contained	No declarable substances contained
SIRIUS HRI 231 W	No declarable substances contained	No declarable substances contained

Product family datasheet

Product description	Declaration no. in SCIP database	Candidate list substance 1
SIRIUS HRI 251 W	No declarable substances contained	No declarable substances contained
SIRIUS HRI 260 W PRO	No declarable substances contained	No declarable substances contained
SIRIUS HRI 280 W	No declarable substances contained	No declarable substances contained
SIRIUS HRI 280 W RO	No declarable substances contained	No declarable substances contained
SIRIUS HRI 281 W	No declarable substances contained	No declarable substances contained
SIRIUS HRI 295 W	No declarable substances contained	No declarable substances contained
SIRIUS HRI 310 W	No declarable substances contained	No declarable substances contained
SIRIUS HRI 310 W RO	No declarable substances contained	No declarable substances contained
SIRIUS HRI 310 W PRO	No declarable substances contained	No declarable substances contained
SIRIUS HRI 310 W S PRO	No declarable substances contained	No declarable substances contained
SIRIUS HRI 311 W	No declarable substances contained	No declarable substances contained
SIRIUS HRI 330 W	No declarable substances contained	No declarable substances contained
SIRIUS HRI 330 W X8	No declarable substances contained	No declarable substances contained
SIRIUS HRI 330 W XL	No declarable substances contained	No declarable substances contained
SIRIUS HRI 371 W +	No declarable substances contained	No declarable substances contained
SIRIUS HRI 371 W S +	No declarable substances contained	No declarable substances contained
SIRIUS HRI 371 W	No declarable substances contained	No declarable substances contained
SIRIUS HRI 371 W S	No declarable substances contained	No declarable substances contained
SIRIUS HRI 381 W S	No declarable substances contained	No declarable substances contained
SIRIUS HRI 380 W Pro	No declarable substances contained	No declarable substances contained
SIRIUS HRI 380 W S PRO	No declarable substances contained	No declarable substances contained
SIRIUS HRI 382 W S	No declarable substances contained	No declarable substances contained
SIRIUS HRI 382 W	No declarable substances contained	No declarable substances contained
SIRIUS HRI 420 W	No declarable substances contained	No declarable substances contained

Product family datasheet

Product description	Declaration no. in SCIP database	Candidate list substance 1
SIRIUS HRI 420 W S	No declarable substances contained	No declarable substances contained
SIRIUS HRI 440 W	No declarable substances contained	No declarable substances contained
SIRIUS HRI 440 W H	No declarable substances contained	No declarable substances contained
SIRIUS HRI 440 W +	No declarable substances contained	No declarable substances contained
SIRIUS HRI 440 W S	No declarable substances contained	No declarable substances contained
SIRIUS HRI 440 W X	No declarable substances contained	No declarable substances contained
SIRIUS HRI 461 W	No declarable substances contained	No declarable substances contained
SIRIUS HRI 461 W S	No declarable substances contained	No declarable substances contained
SIRIUS HRI 462 W	No declarable substances contained	No declarable substances contained
SIRIUS HRI 470 W	No declarable substances contained	No declarable substances contained
SIRIUS HRI 470 W S	No declarable substances contained	No declarable substances contained
SIRIUS HRI 470 W RO	No declarable substances contained	No declarable substances contained
SIRIUS HRI 470 W XL	No declarable substances contained	No declarable substances contained
SIRIUS HRI 471 W SN	No declarable substances contained	No declarable substances contained
SIRIUS HRI 550 W XL	No declarable substances contained	No declarable substances contained
SIRIUS HRI 550 W	No declarable substances contained	No declarable substances contained
HRI 580 W F	No declarable substances contained	No declarable substances contained

Product family datasheet

Safety advice

Because of their high luminance, UV radiation and high internal pressure during operation, SIRIUS HRI lamps may only be operated in enclosed lamp casings specially constructed for the purpose. Appropriate filters must ensure that UV radiation is reduced to an acceptable level. Mercury is released if the lamp breaks. Special safety precautions must be taken. Information on safety and handling is available on request or can be found in the leaflet included with the lamp or in the operating instructions.

Application advice

For more detailed application information and graphics please see product datasheet.

Disclaimer

Subject to change without notice. Errors and omission excepted. Always make sure to use the most recent release.