

HALOTRONIC-PROFESSIONAL HTL

Electronic transformers for low-voltage halogen lamps



Areas of application

- Effect and accent lighting
- Living rooms
- Object lighting
- Conference rooms
- Restaurants
- Recessed and surface-mounted furniture luminaires
- Shop lighting
- Event rooms

Product family benefits

- Very low power loss thanks to high efficacy
- Through-wiring possible on the primary side
- Large temperature range
- Protective operation throughout the entire partial-load range for long lamp life
- High efficiency

Product family features

- Line frequency: 50...60 Hz
- RI suppression: to EN 55015 (A1: 2007)/CISPR 15, EN 55022
- Line harmonics according to EN 61000-3-2
- Immunity according to EN 61547
- Safety: to EN 61347
- Short-circuit protection, overload protection, overtemperature protection: electronically reversible
- Electrical isolation between the primary side and the secondary side
- Energy efficiency: ≥ 91 % (according to ErP regulation 2012/1194/EC)
- Dimmable on the leading edge and trailing edge

Product family datasheet

Technical data

Electrical data

Product description	Lamp wattage	Line current	Nominal voltage	Operating frequency	Nominal output voltage
HTL 105/230...240	35...105 W	0.44 A ¹⁾	230...240 V	40 kHz ²⁾	11.6 / 11.3 V ³⁾
HTL 225/230...240	50...225 W	0.90 A ¹⁾	230...240 V	50 kHz ²⁾	11.6 / 11.7 V ⁴⁾

¹⁾ Effectively

²⁾ Approximately

³⁾ 105 W / 35 W

⁴⁾ 225 W / 50 W

Dimensions & weight

Product description	Length	Width	Height	Cable cross-section, input side	Cable cross-section, output side
HTL 105/230...240	170.0 mm	44.0 mm	34.0 mm	2.5 mm ² ¹⁾	4.0 mm ² ¹⁾
HTL 225/230...240	170.0 mm	44.0 mm	34.0 mm	2.5 mm ² ¹⁾	4.0 mm ² ¹⁾

Product description	Wire preparation length, input side	Wire preparation length, output side	Mounting hole spacing, length	Product weight
HTL 105/230...240	14 / 8.0 mm ²⁾	14 / 8.0 mm ²⁾	140.0 mm	160.00 g
HTL 225/230...240	14 / 8.0 mm ²⁾	14 / 8.0 mm ²⁾	140.0 mm	225.00 g

¹⁾ Maximum

²⁾ Cable sheath / Wire

Product family datasheet

Product line drawing

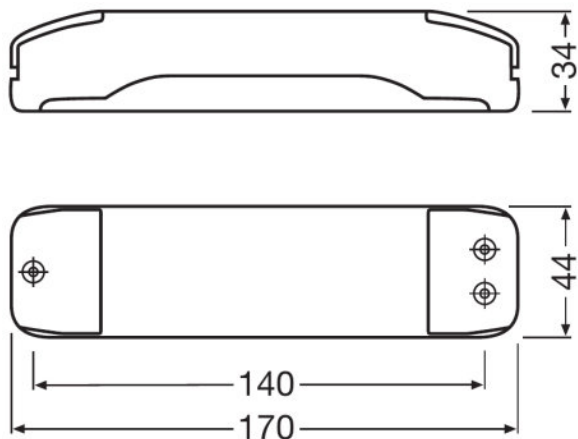

HTL 105/230...240, HTL 225/230...240

Temperatures & operating conditions

Product description	Ambient temperature range
HTL 105/230...240	-20...+50 °C
HTL 225/230...240	-20...+50 °C

Additional product data

Product description	Design / version
HTL 105/230...240	Long with cable clamp
HTL 225/230...240	Long with cable clamp

Product family datasheet

Capabilities

Product description	Dimming method
HTL 105/230...240	Trailing- or leading-edge phase control for inductive load dimmers
HTL 225/230...240	Trailing- or leading-edge phase control for inductive load dimmers

Certificates & standards

Product description	Approval marks – approval
HTL 105/230...240	ENEC 10 / VDE / VDE-EMC / EAC
HTL 225/230...240	ENEC 10 / VDE / VDE-EMC / EAC

Product description	Standards	Type of protection
HTL 105/230...240	Acc. to EN 61347/Acc. to EN 55015/Acc. to EN 61000-3-2/Acc. to EN 61547/Acc. to EN 61047	IP20
HTL 225/230...240	Acc. to EN 61347/Acc. to EN 55015/Acc. to EN 61000-3-2/Acc. to EN 61547/Acc. to EN 61047	IP20

Logistical data

Product description	Commodity code
HTL 105/230...240	850440909000
HTL 225/230...240	850440909000

Application advice

For more detailed application information and graphics please see product datasheet.

Sales and Technical Support















Sales and Technical Support www.osram.com

Country specific information

Product description	Product code	METEL code	SEG-No.	STK number	UK Org
HTL 105/230...240	4008321927019	OSRH TL105	-	4030497	-
HTL 105/230...240	4008321927019	OSRH TL105	-	4030497	-
HTL 225/230...240	4008321927026	OSRH TL225	-	4030498	-
HTL 225/230...240	4008321927026	OSRH TL225	-	4030498	-

Product family datasheet

Download Data

File	
	User instruction HTLHTMHTN UI 080518
	Addon Technical Information 321705_ATI HTL 105 (GB)
	Certificates 334969_ENEC-Marks approval
	Certificates 504178_EAC HT family
	Certificates VDE ENEC Certificate 40024665
	Certificates VDE EMC Certificate 40024187
	Declarations of conformity 710835_EC-DOC Halotronic
	Installation/Operation notice 334136_Technical guide - HALOTRONIC for low-voltage halogen lamps
	Installation/Operation notice 334738_HALOTRONIC – Manual
	CAD data 3-dim 317452_HTL 105230-240 and HTL 225230-240 9900052
	CAD data 3-dim 317453_HTL 105230-240 and HTL 225230-240 9900052
	CAD data 3-dim 317454_HTL 105230-240 and HTL 225230-240 9900052
	CAD data PDF 317451_HTL 105230-240 and HTL 225230-240 9900052
	Addon Technical Information 321707_ATI HTL 225 (GB)

Logistical Data

Product code	Product description	Packaging unit (Pieces/Unit)	Dimensions (length x width x height)	Volume	Gross weight
4008321927019	HTL 105/230...240	Shipping carton box 10	235 mm x 89 mm x 183 mm	3.83 dm ³	1711.00 g
4008321927026	HTL 225/230...240	Shipping carton box 10	182 mm x 89 mm x 230 mm	3.73 dm ³	2361.00 g

The mentioned product code describes the smallest quantity unit which can be ordered. One shipping unit can contain one or more single products. When placing an order, for the quantity please enter single or multiples of a shipping unit.

Product family datasheet

Disclaimer

Subject to change without notice. Errors and omission excepted. Always make sure to use the most recent release.